

IMAGE A

1- Fix to rails in front of the module 3mm and fix the mounting hole centers on the extent in module (IMAGE A)

2- Fix the mechanism on rails with screw (IMAGE B).

You must check work of mechanism.

3- Fix to module cover on mechanism with help of cover connection parts (IMAGE C).

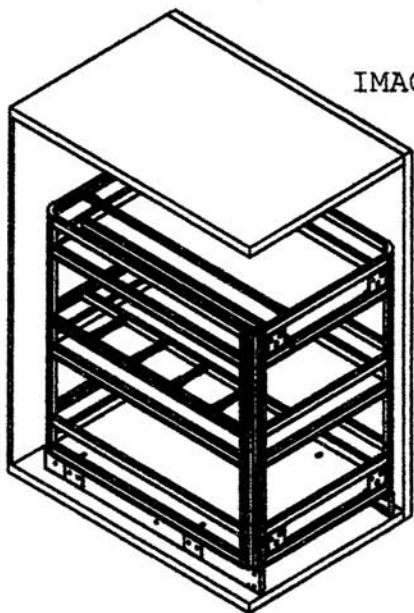

IMAGE B

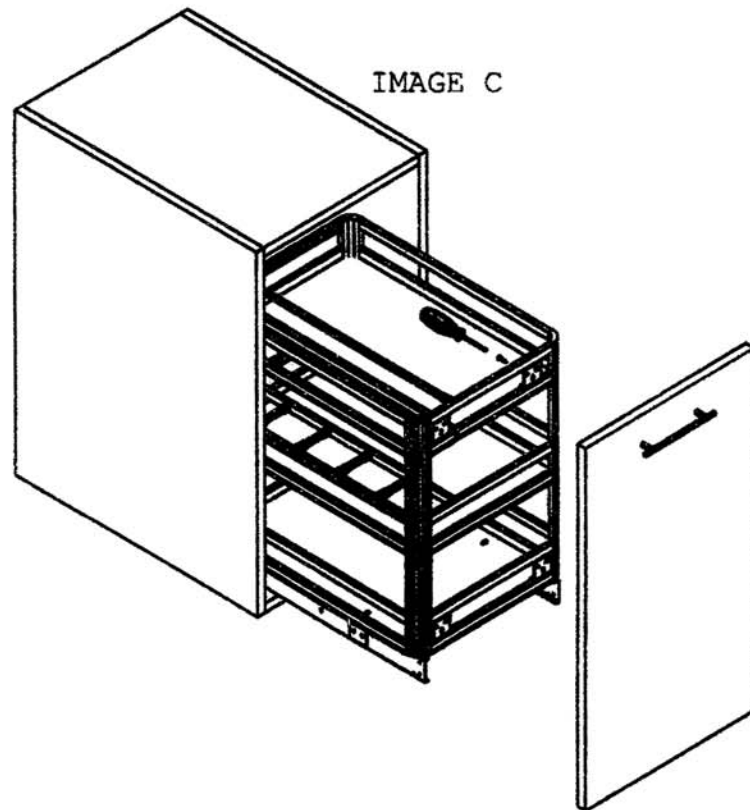

IMAGE C

ITEMS PART		
NO	PART NAME	PCS.
1	RAIL	1Set.
2	COVER CONNECTION PART	4Pcs.
3	BASKET	1Pcs.
4	YSB SCREW M5x10	4Pcs.

**BM21ORG1**